

# ROTA

17016.4K | 17017.4K

oktaplex  
lighting

- |           |                               |           |                         |           |                          |
|-----------|-------------------------------|-----------|-------------------------|-----------|--------------------------|
| <b>DE</b> | - Montageanleitung            | <b>NL</b> | - Montage-instructies   | <b>RO</b> | - Instrucțiuni de montaj |
| <b>FR</b> | - Instructions de montage     | <b>SE</b> | - Monteringsanvisningar | <b>PL</b> | - Instrukcje montażu     |
| <b>ES</b> | - Instrucciones de montaje    | <b>CZ</b> | - Návod k montáži       | <b>GB</b> | - Mounting instructions  |
| <b>IT</b> | - Istruzioni per il montaggio | <b>SK</b> | - Návod na montáž       |           |                          |

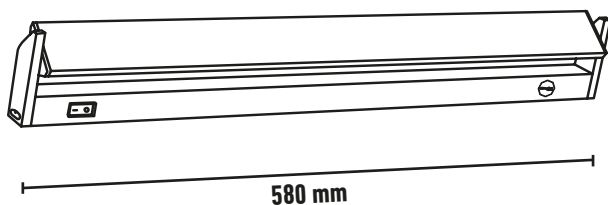
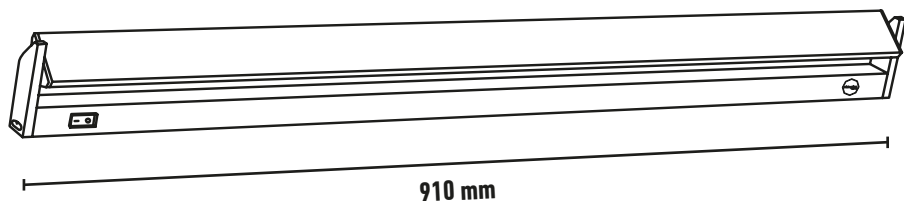

WhatsApp



**FR**

Cet appareil,  
ses accessoires,  
piles et cordons  
se recyclent

À DÉPOSER  
EN MAGASIN



OU

À DÉPOSER  
EN DÉCHÈTERIE



Points de collecte sur [www.quefairedemesdechets.fr](http://www.quefairedemesdechets.fr)

# ROTA

Erweiterbare LED- Leuchte für Innen mit Schalter / Luminaire LED d'intérieur extensible avec interrupteur / Luz LED interior extensible con interruptor / Luce interna a LED estensibile con interruttore / Uitschuifbare LED-binnenverlichting met schakelaar / Utdragbar invändig LED-lampa med strömbrytare / Výsuvné vnitřní světlo LED s vypínačem / Výsuvné vnútorné svetlo LED s vypínačom / Lumină interioră extensibilă cu LED cu întrerupător / Wysuwane wewnętrzne oświetlenie LED z przełącznikiem / Extendable LED light for indoor with switch

17016.4K

17017.4K

Nennspannung / Tension nominale / Tensión nominal / Tensione nominale / Nominaal voltage / Märkspänning / Jmenovité napětí / Menovité napätie / Tensiunea nominală / Napięcie nominalne / rated voltage

AC 180-265 V  
50-60Hz

Nennleistung / Puissance nominale / Potencia nominal / Potenza nominale / Nominaal vermogen / Märkeffekt / Jmenovitý výkon / Menovitý výkon / Putere nominală / Moc znamionowa / rated power

10W

15W

Lichtleistung / Puissance lumineuse / Potencia luminosa / Potenza luminosa / Lichtrendement / Ljusflöde / Světelný výkon / Svetelný výkon / Producția de lumină / Moc światła / Light output

800lm

1200lm

Farbtemperatur / Température de couleur / Temperatura de color / Temperatura di colore / Kleurtemperatuur / Färgtemperatur / Teplota barev / Teplota farieb / Temperatura de culoare / Temperatura barwowa / Color temperature

4000K

Farbwiedergabeindex / Ra / IRC / CRI / Index farebného podania

RA ≥ 80

Energieeffizienzklasse / Classe d'efficacité énergétique / Clase de eficiencia energética / Classe di efficienza energetica / Energie-effizienzklasse / Klass för energieeffektivitet / Trieda energetickej účinnosti / Trída energetickej účinnosti / Clasa de eficiență energetică / Klasa efektywności energetycznej / Energy efficiency class

F

Schutzklasse / Indice de protection / Clase de protección / Classe di protezione / Beschermingsklasse / Skyddsklass / Trída ochrany / Trieda ochrany / Clasa de protecție / Klasa ochrony / Protection class

II

Schutzart / Indice de protection IP / grado de protección / Livello di protezione IP / IP mate van bescherming / IP-klasse / Stupeň ochrany / Stupeň IP ochrany / Clasa de protecție IP / Klasa ochrony IP / Protection class

IP20

Umgebungstemperatur / Température ambiante / Temperatura ambiente / Temperatura ambiente / Omgevingstemperatuur / Omgivningstemperatur / Okolní teplota / Okolită teplota / Temperatura ambiantă / Temperatura otoczenia / Ambient temperature

-20 - +40°C



# INSTALLATION

**1**

410 mm - 17016.4K  
742 mm - 17017.4K

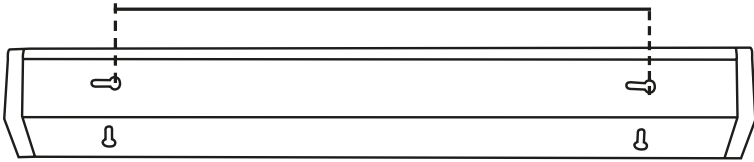

mountable on 2 sides

**option 1**

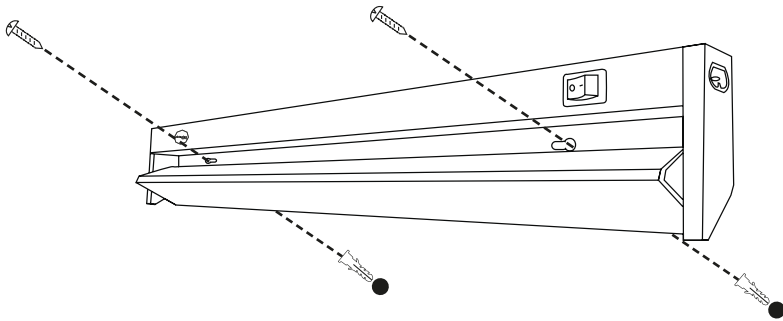

**option 2**

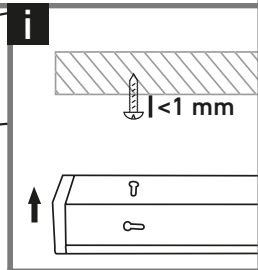
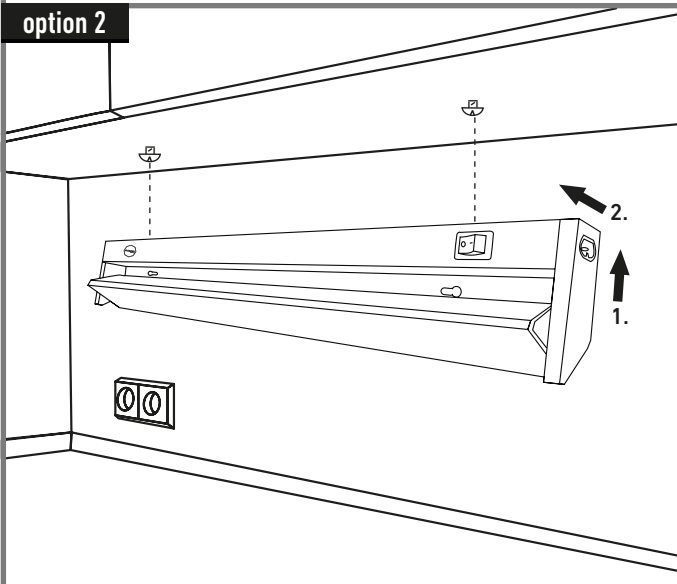

# SETTINGS

2

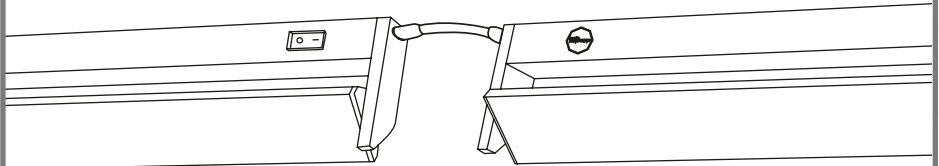
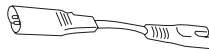
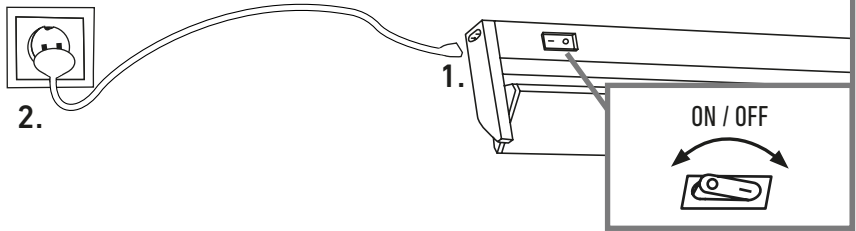

max. 12 pcs.

WhatsApp



ETAPLEX GmbH · Langerstr. 22 · 40233 Düsseldorf · Germany

+49 211 9726 4070 · info@etaplex.de · oktaplex.de